

Warmington Gas Open Fire

TG 1500 Firebox

Fire, Flue System to Comply with NZS 5261 / 5262 : 2003

Due to continued product improvement, Warmington Ind LTD reserves the right to change product specifications without prior notification.

Read all the Instructions carefully before commencing the Installation. Failure to follow these instructions may result in a fire hazard and void the warranty

For Specification See: www.warmington.co.nz

Copyright ©

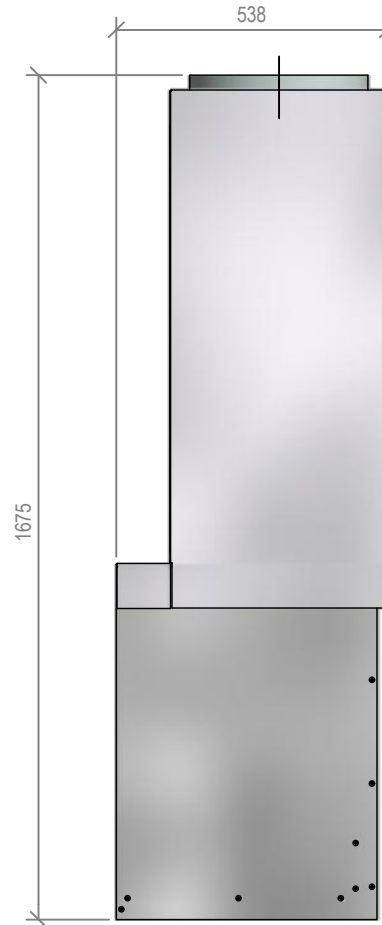
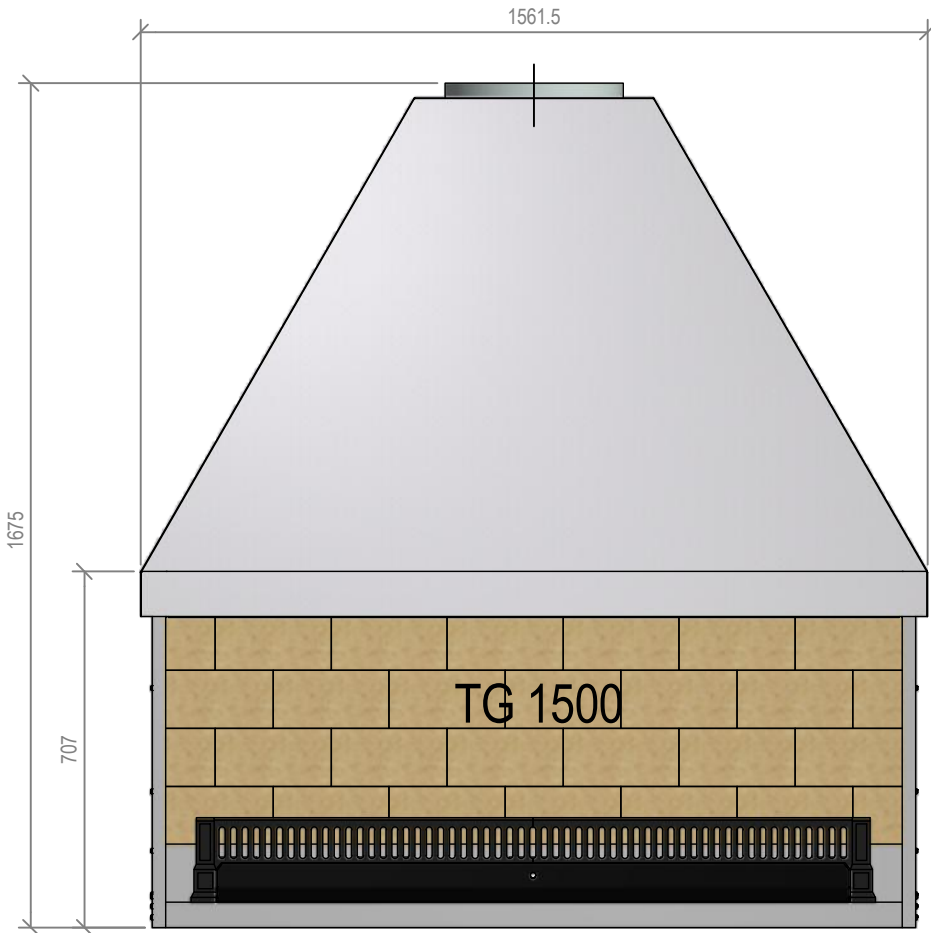

Warmington Industries Ltd.			
PH: 09 273 9227 FAX: 09 273 9241 WEB: www.warmington.co.nz			
TITLE	TG 1500 FIREBOX		
DRAWN	ROBERT	DATE	28/04/17
SCALE	NOT TO SCALE	REVISION	01

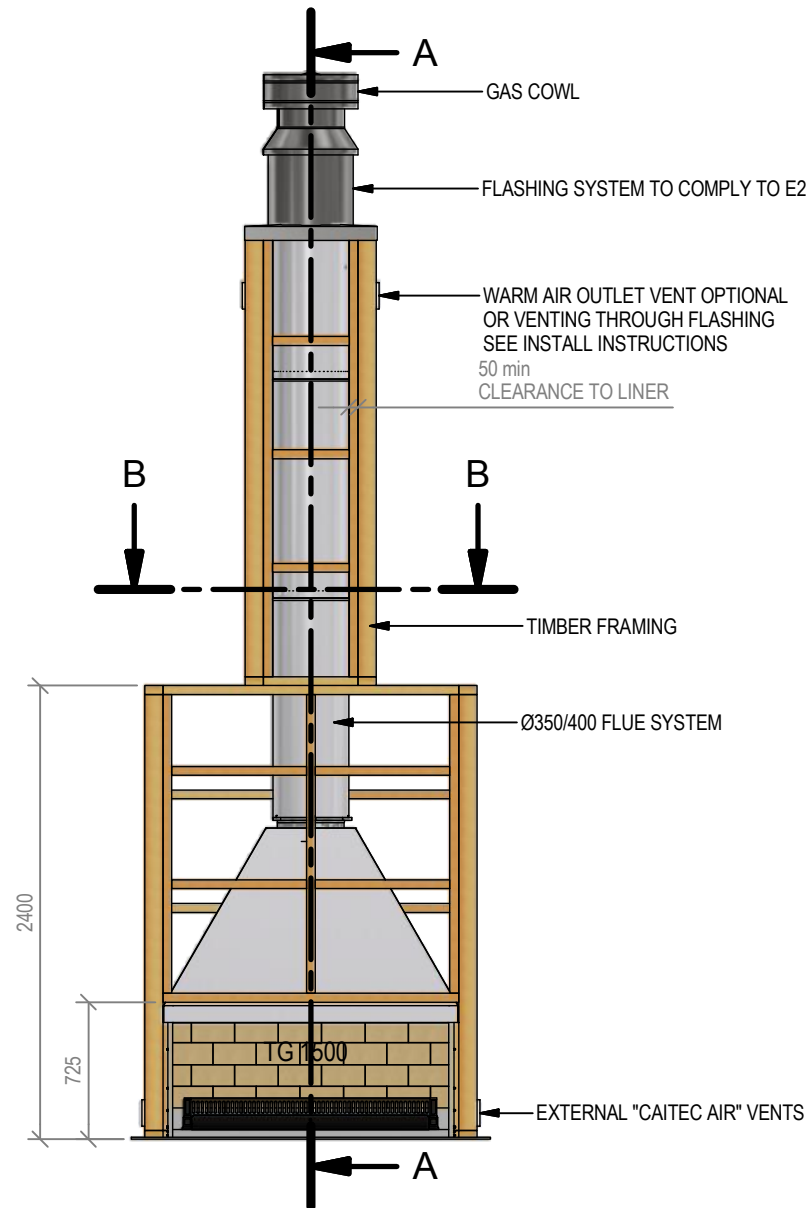
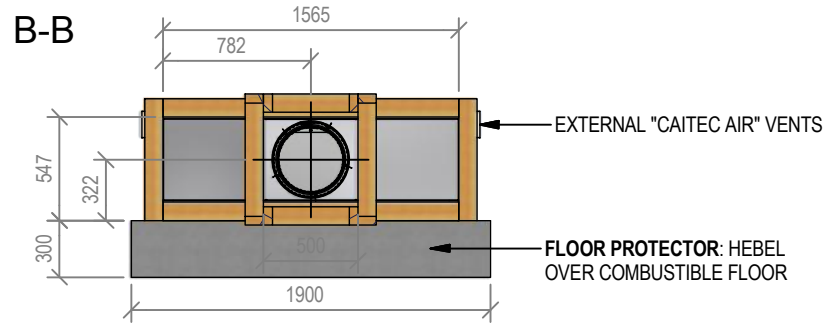

Warmington Gas Open Fire

TG 1500 Timber Framing

Fire, Flue System to Comply with NZS 5261 / 5262 : 2003

Due to continued product improvement, Warmington Ind LTD reserves the right to change product specifications without prior notification.

Read all the Instructions carefully before commencing the Installation. Failure to follow these instructions may result in a fire hazard and void the warranty

For Specification See: www.warmington.co.nz

Copyright ©

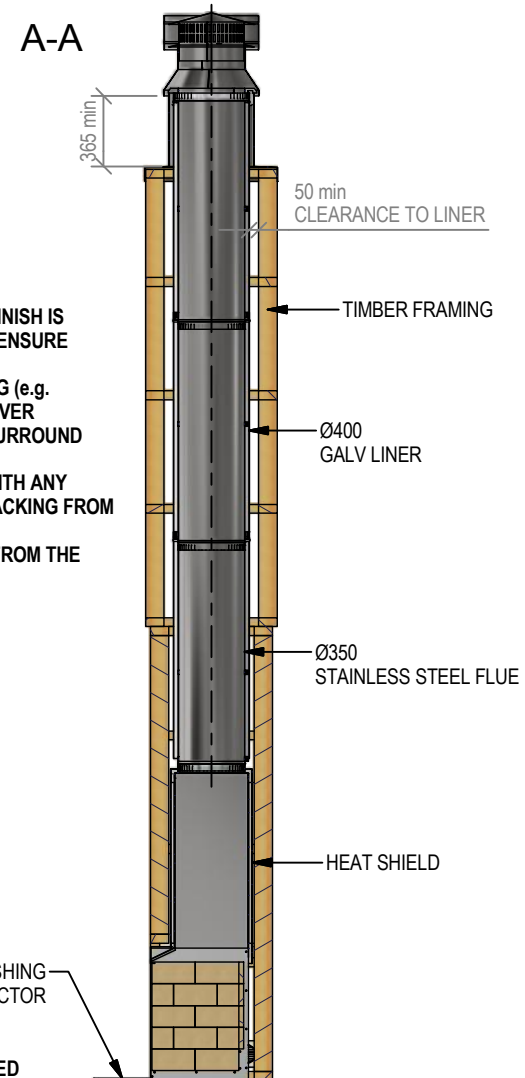

IMPORTANT NOTE:

WHERE AN INTERNAL WALL BOARD FINISH IS REQUIRED AROUND THE FIREPLACE, ENSURE ALLOWANCE IS MADE TO PLACE NON COMBUSTIBLE INTERNAL WALL LINING (e.g. PROMINA ETERPAN, SUPALUX) TO COVER THE EXTENT OF THE HEBEL BLOCK SURROUND

DIRECTLY TOUCHING THE FIREBOX WITH ANY BOARD OR PLASTER MAY CAUSE CRACKING FROM HEAT EXPANSION
ALLOW 3mm MINIMUM SPACE AWAY FROM THE FIREBOX

NOTE:
WARMINGTON CAITEC AIR IS REQUIRED
SEE SPECIFIC INSTALL INSTRUCTION

Warmington Industries Ltd.			
PH: 09 273 9227 FAX: 09 273 9241 WEB: www.warmington.co.nz			
TITLE	TG 1500 TIMBER FRAMING	DATE	28/04/17
DRAWN	ROBERT	REVISION	01
SCALE	NOT TO SCALE		

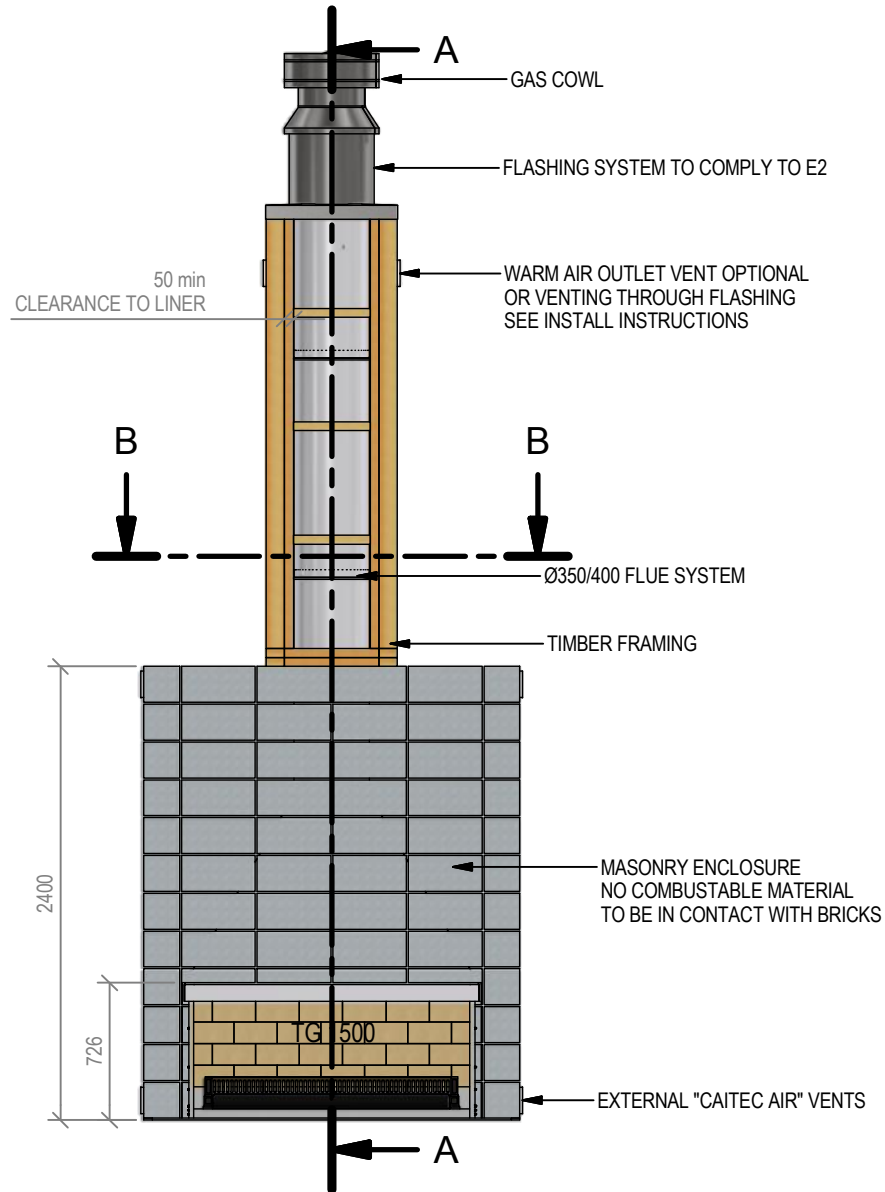
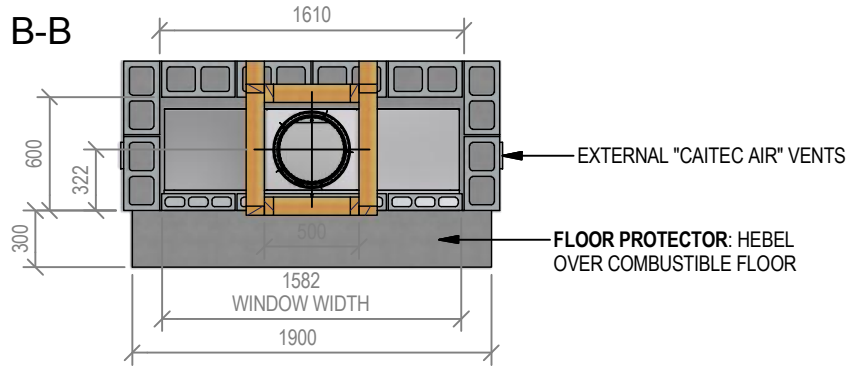

Warmington Gas Open Fire

TG 1500 Block Enclosure

Fire, Flue System to Comply with NZS 5261 / 5262 : 2003

Due to continued product improvement, Warmington Ind LTD reserves the right to change product specifications without prior notification.

Read all the Instructions carefully before commencing the Installation. Failure to follow these instructions may result in a fire hazard and void the warranty

For Specification See: www.warmington.co.nz

Copyright ©

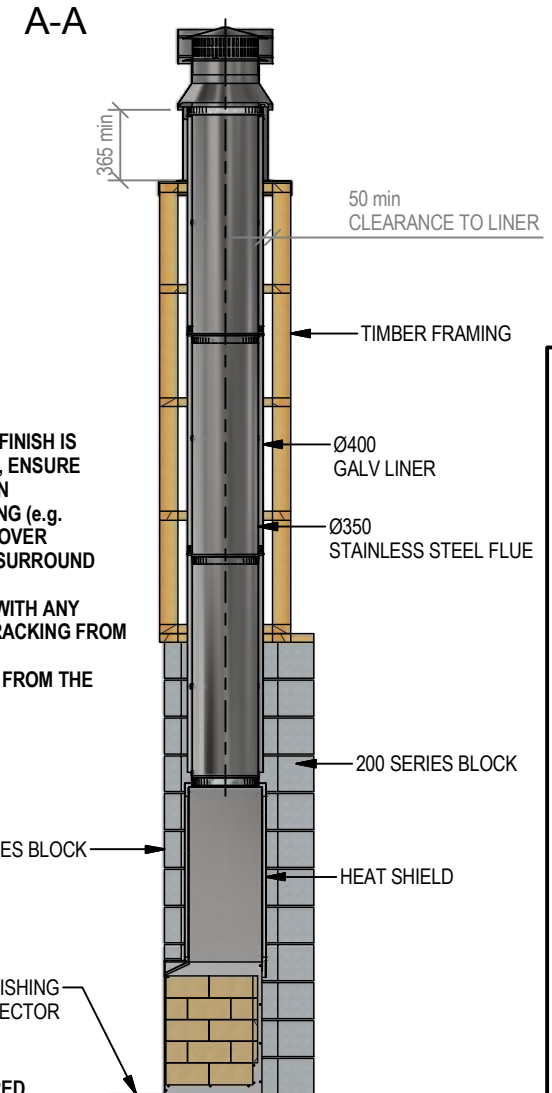

IMPORTANT NOTE:
WHERE AN INTERNAL WALL BOARD FINISH IS REQUIRED AROUND THE FIREPLACE, ENSURE ALLOWANCE IS MADE TO PLACE NON COMBUSTIBLE INTERNAL WALL LINING (e.g. PROMINA ETERPAN, SUPALUX) TO COVER THE EXTENT OF THE HEBEL BLOCK SURROUND

DIRECTLY TOUCHING THE FIREBOX WITH ANY BOARD OR PLASTER MAY CAUSE CRACKING FROM HEAT EXPANSION
ALLOW 3mm MINIMUM SPACE AWAY FROM THE FIREBOX

NOTE:
WARMINGTON CAITEC AIR IS REQUIRED
SEE SPECIFIC INSTALL INSTRUCTION

Warmington Industries Ltd.			
PH: 09 273 9227 FAX: 09 273 9241 WEB: www.warmington.co.nz			
TITLE	TG 1500 BLOCK ENCLOSURE	DATE	28/04/17
DRAWN	ROBERT	REVISION	01
SCALE	NOT TO SCALE		