

Warmington Open Wood Fire

SI 1250 Single Flue

NOTE: Requires Hebel Enclosure

Fire, Flue System to Comply with AS/NZS 2918:2001

Due to continued product improvement, Warmington Ind LTD reserves the right to change product specifications without prior notification.

Read all the Instructions carefully before commencing the Installation. Failure to follow these instructions may result in a fire hazard and void the warranty

For Specification See: www.warmington.co.nz

Copyright ©

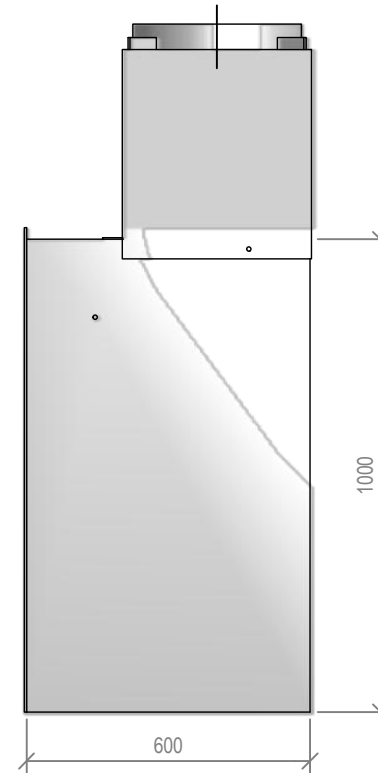
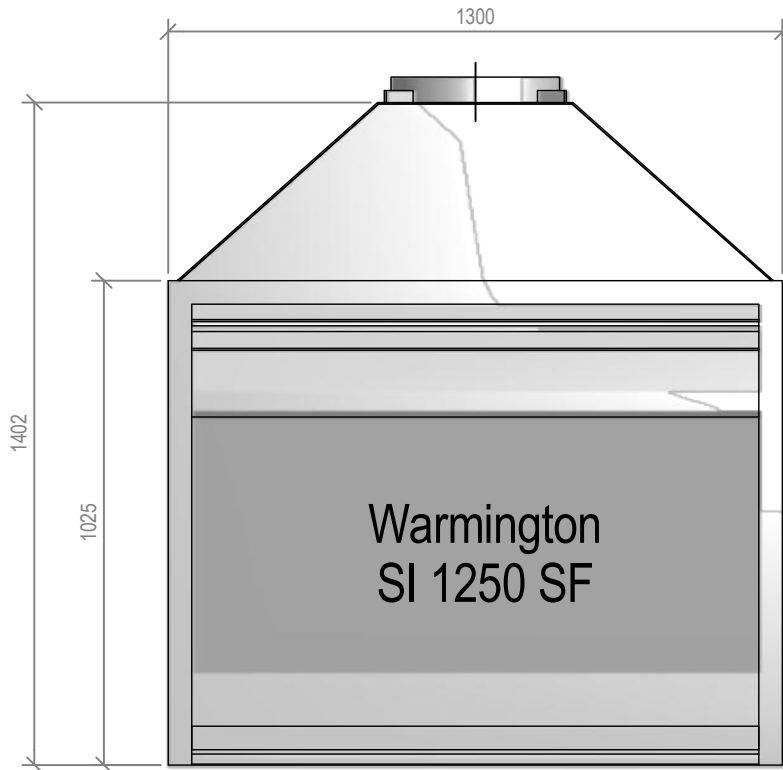

Warmington Industries Ltd.	
PH: 09 273 9227 FAX: 09 273 9241 WEB: www.warmington.co.nz	
TITLE	SI 1250 SINGLE FLUE FIREBOX
DRAWN	ROBERT
SCALE	NOT TO SCALE
DATE	13/04/11
REVISION	01

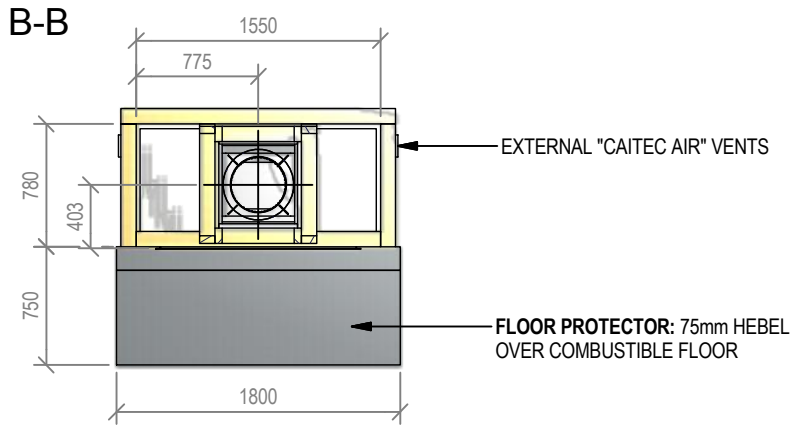

Warmington Open Wood Fire

SI 1250 Single Flue Timber Framing

NOTE: Requires Hebel Enclosure

Fire, Flue System to Comply with ASNZS 2918:2001

Due to continued product improvement, Warmington Ind LTD reserves the right to change product specifications without prior notification.

Read all the Instructions carefully before commencing the Installation. Failure to follow these instructions may result in a fire hazard and void the warranty

For Specification See: www.warmington.co.nz

Copyright ©

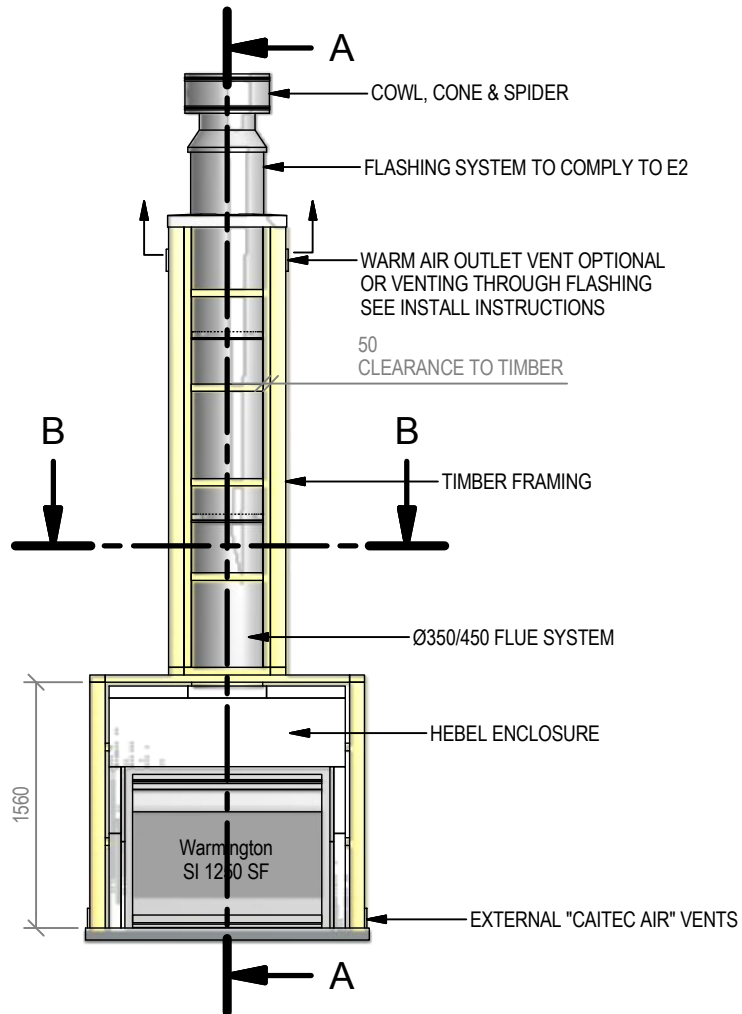

IMPORTANT NOTE:

WHERE AN INTERNAL WALL BOARD FINISH IS REQUIRED AROUND THE FIREPLACE, ENSURE ALLOWANCE IS MADE TO PLACE NON COMBUSTIBLE INTERNAL WALL LINING (e.g. PROMINA ETERPAN, SUPALUX) TO COVER THE EXTENT OF THE HEBEL BLOCK SURROUND

DIRECTLY TOUCHING THE FIREBOX WITH ANY BOARD OR PLASTER MAY CAUSE CRACKING FROM HEAT EXPANSION
ALLOW 3mm MINIMUM SPACE AWAY FROM THE FIREBOX

ENSURE THE LOWER AIR INTAKE IS NOT OBSTRUCTED

ALLOW FINISHING ON FLOOR PROTECTOR

NOTE:
WARMINGTON CAITEC AIR IS REQUIRED
SEE SPECIFIC INSTALL INSTRUCTION

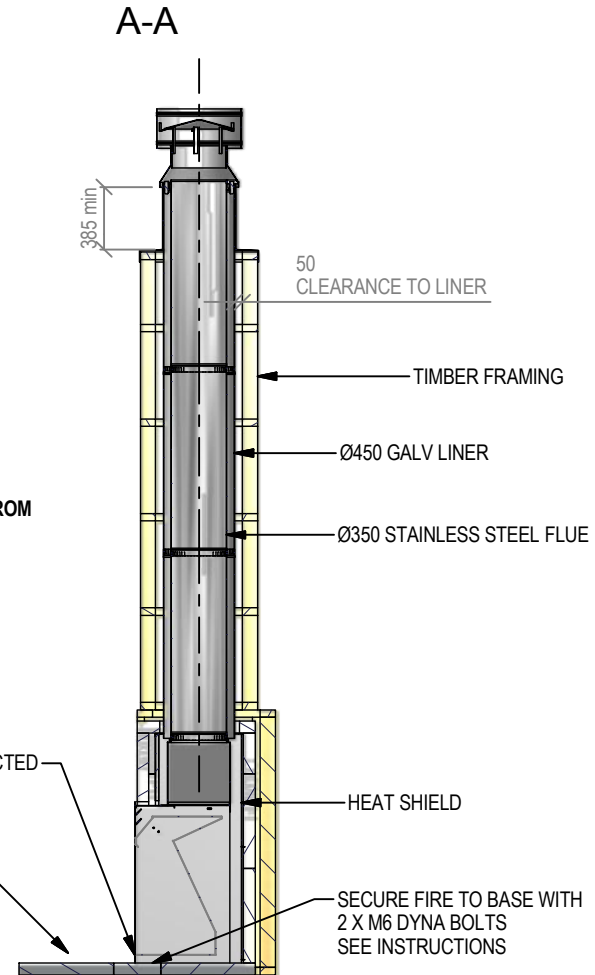

Warmington Industries Ltd.			
PH: 09 273 9227 FAX: 09 273 9241 WEB: www.warmington.co.nz			
TITLE	SI 1250 SINGLE FLUE TIMBER FRAMING	DATE	13/04/11
DRAWN	ROBERT	REVISION	01
SCALE	NOT TO SCALE		

B-B

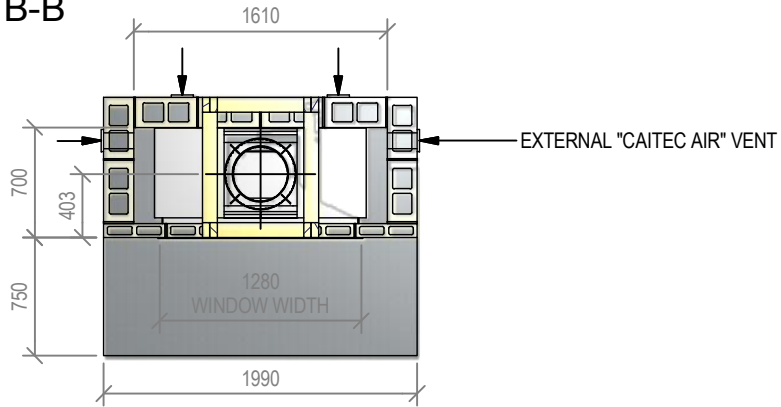

Warmington Open Wood Fire

SI 1250 Single Flue Block Enclosure

Fire, Flue System to Comply with ASNZS 2918:2001

Due to continued product improvement, Warmington Ind LTD reserves the right to change product specifications without prior notification.

Read all the Instructions carefully before commencing the Installation. Failure to follow these instructions may result in a fire hazard and void the warranty

For Specification See: www.warmington.co.nz

Copyright ©

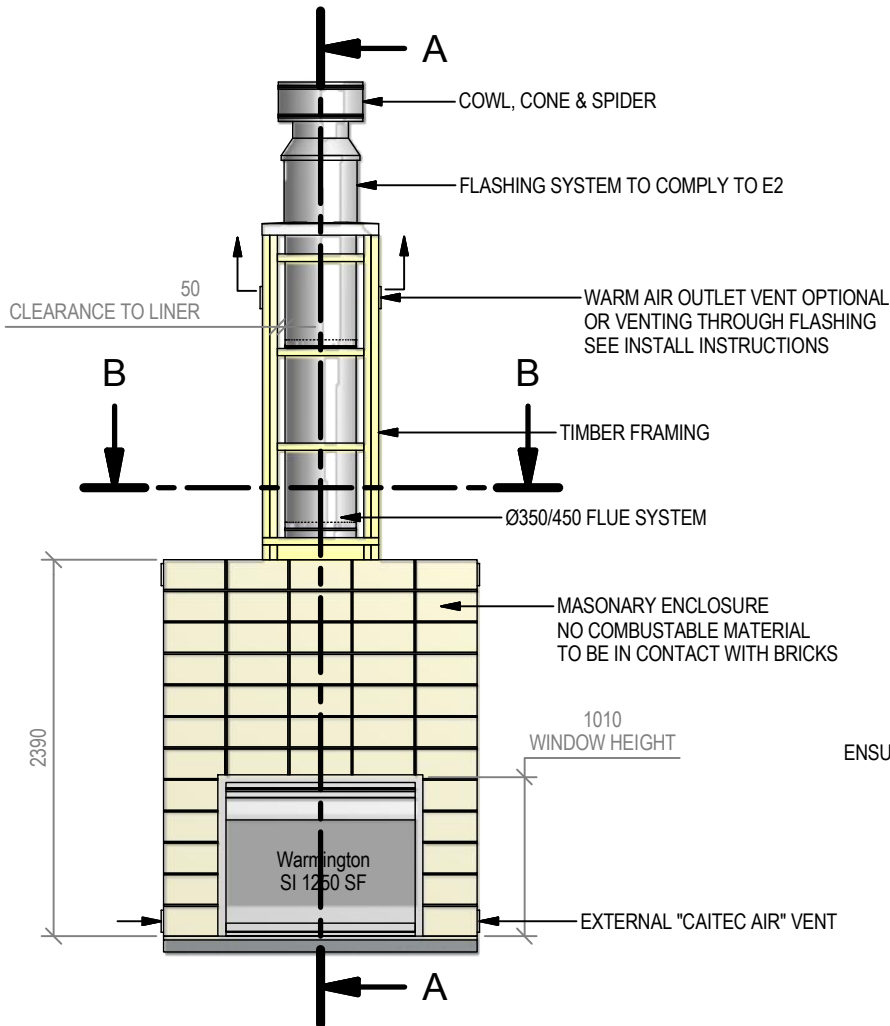

A-A

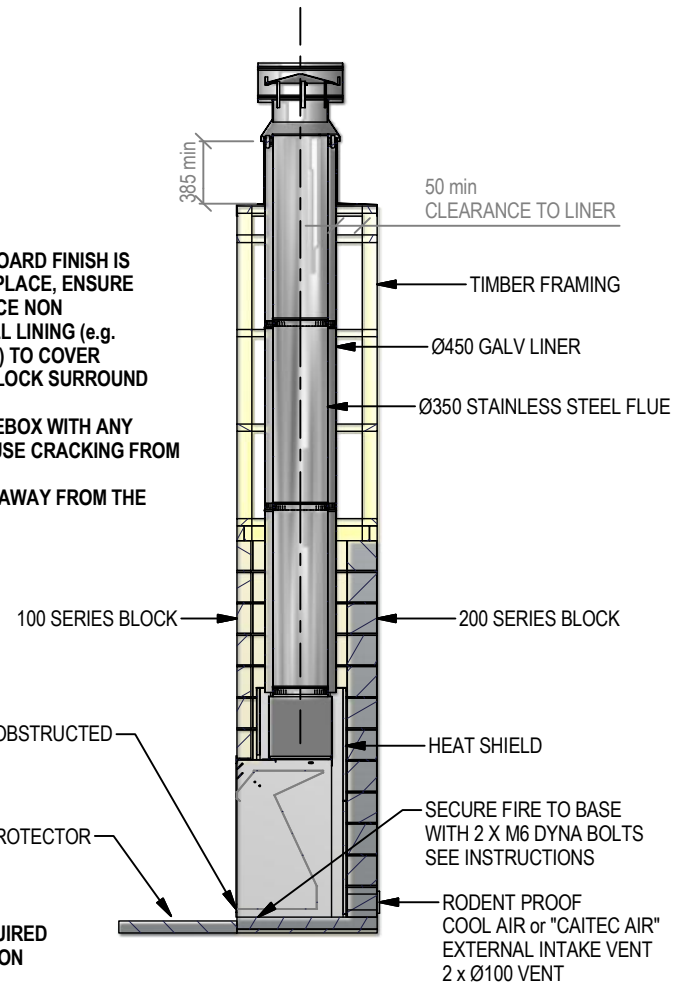

IMPORTANT NOTE:

WHERE AN INTERNAL WALL BOARD FINISH IS REQUIRED AROUND THE FIREPLACE, ENSURE ALLOWANCE IS MADE TO PLACE NON COMBUSTIBLE INTERNAL WALL LINING (e.g. PROMINA ETERPAN, SUPALUX) TO COVER THE EXTENT OF THE HEBEL BLOCK SURROUND

DIRECTLY TOUCHING THE FIREBOX WITH ANY BOARD OR PLASTER MAY CAUSE CRACKING FROM HEAT EXPANSION
ALLOW 3mm MINIMUM SPACE AWAY FROM THE FIREBOX

NOTE:
WARMINGTON CAITEC AIR IS REQUIRED
SEE SPECIFIC INSTALL INSTRUCTION

Warmington Industries Ltd.			
PH: 09 273 9227 FAX: 09 273 9241 WEB: www.warmington.co.nz			
TITLE	SI 1250 SINGLE FLUE BLOCK ENCLOSURE	DATE	13/04/11
DRAWN	ROBERT	REVISION	01
SCALE	NOT TO SCALE		