

Warmington Flueless Outdoor Gas Open Fire

SG 900 Outdoor Flueless Firebox

Fire, Flue System to Comply with NZS 5261 / 5262 : 2003

Due to continued product improvement, Warmington Ind LTD reserves the right to change product specifications without prior notification.

Read all the Instructions carefully before commencing the Installation. Failure to follow these instructions may result in a fire hazard and void the warranty

For Specification See: www.warmington.co.nz

Copyright ©

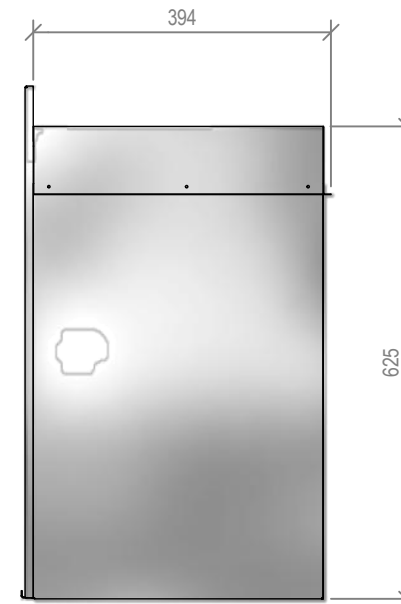
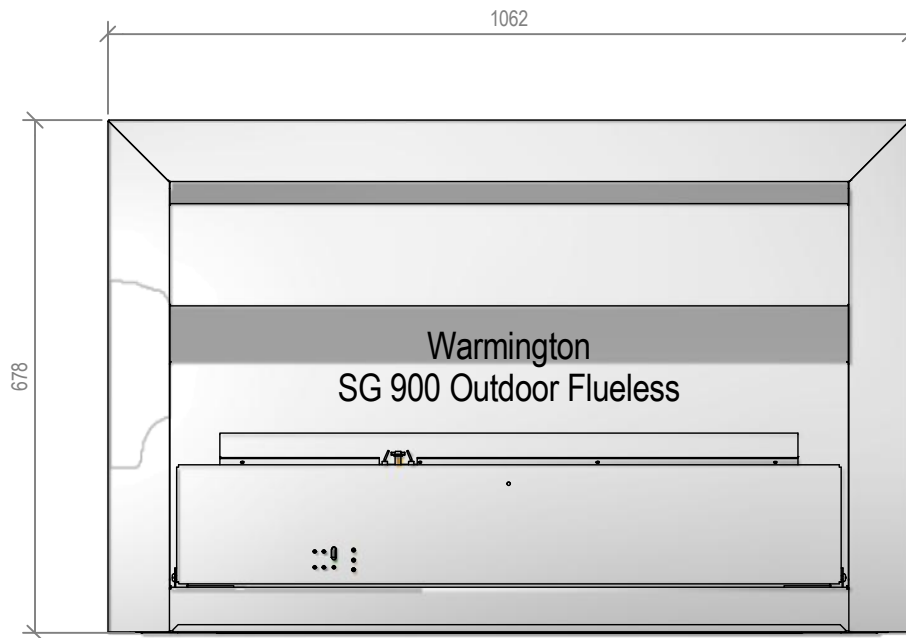

Warmington Industries Ltd.			
PH: 09 273 9227 FAX: 09 273 9241 WEB: www.warmington.co.nz			
TITLE	SG 900 OUTDOOR FLUELESS FIREBOX		
DRAWN	ROBERT	DATE	13/04/11
SCALE	NOT TO SCALE	REVISION	01

B-B

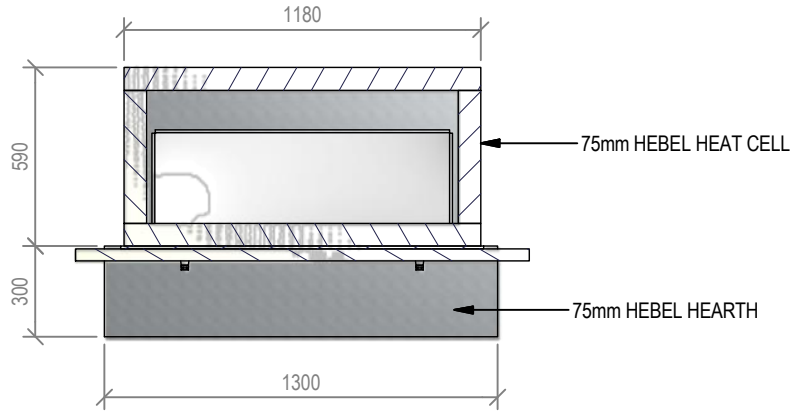

Warmington Flueless Outdoor Gas Open Fire

SG 900 Outdoor Flueless Hebel Enclosure

Fire, Flue System to Comply with NZS 5261 / 5262 : 2003

Due to continued product improvement, Warmington Ind LTD reserves the right to change product specifications without prior notification.

Read all the instructions carefully before commencing the Installation. Failure to follow these instructions may result in a fire hazard and void the warranty

For Specification See: www.warmington.co.nz

Copyright ©

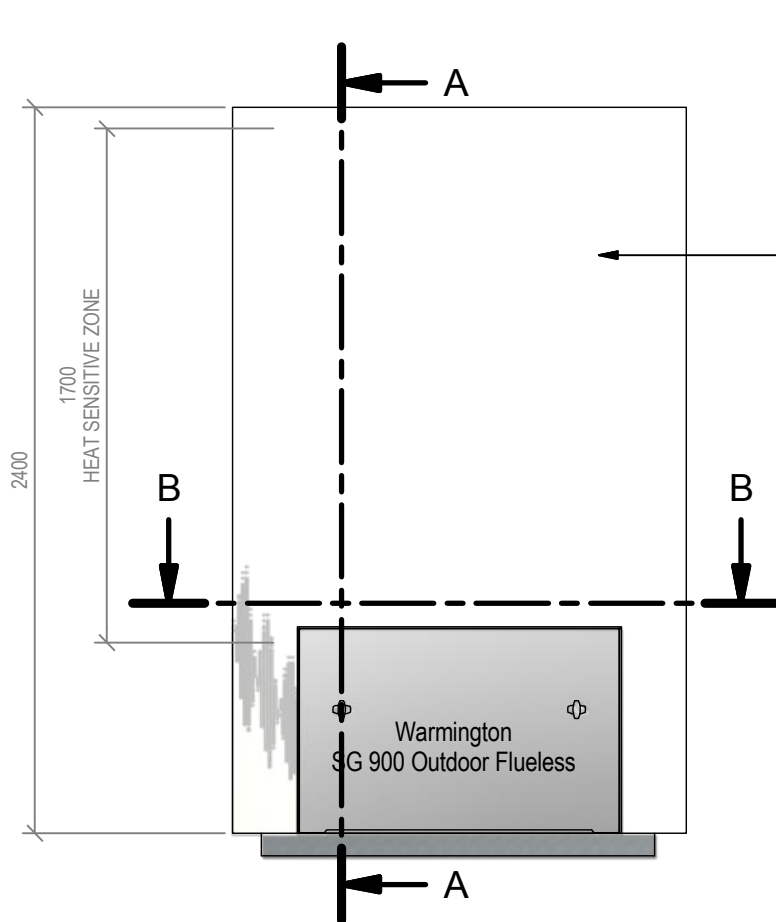

A-A

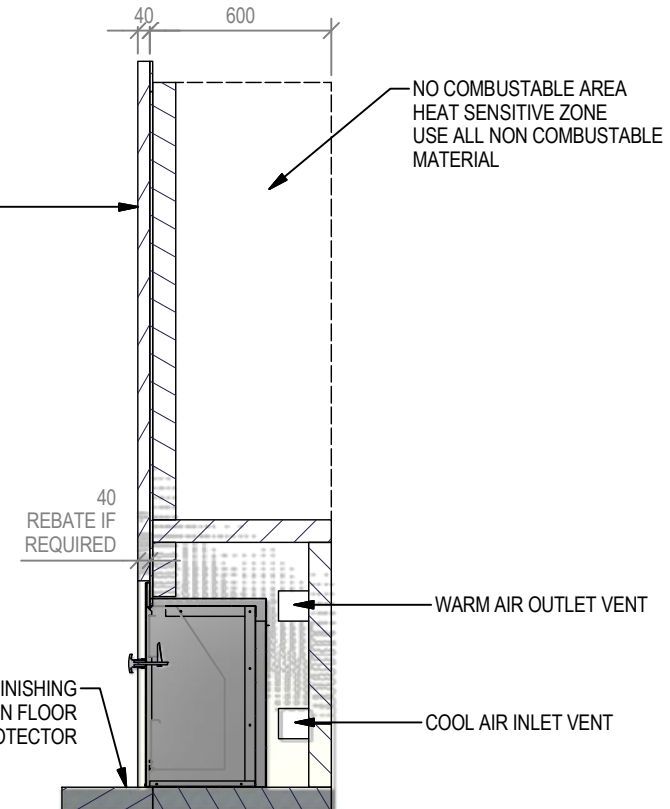

NO COMBUSTABLE MATERIAL TO BE USED IN OR ON THIS AREA

**NOTE:
GAS TEMPERATURE WILL EXCEED 150°C RUNNING UP THE FRONT FACE**

REBATE TO REDUCE WATER ENTERING THE FIRE

THESE FIRES ARE FOR OUTSIDE USE ONLY NOT TO BE INSTALLED INDOORS

ENSURE VENTING IS NOT RESTRICTED OR THE AIR FLOW IMPINGES ON ANY COMBUSTIBLE MATERIAL

Warmington Industries Ltd.			
PH: 09 273 9227 FAX: 09 273 9241 WEB: www.warmington.co.nz			
TITLE	SG 900 OUTDOOR FLUELESS HEBEL ENCLOSURE	DATE	13/04/11
DRAWN	ROBERT	REVISION	01
SCALE	NOT TO SCALE		

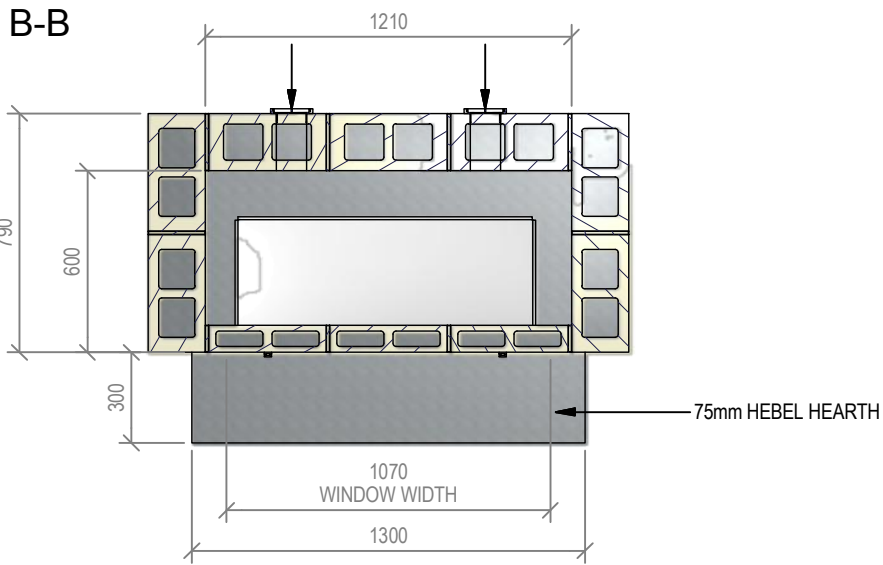

Warmington Flueless Outdoor Gas Open Fire

SG 900 Outdoor Flueless Block Enclosure

Fire, Flue System to Comply with NZS 5261 / 5262 : 2003

Due to continued product improvement, Warmington Ind LTD reserves the right to change product specifications without prior notification.

Read all the Instructions carefully before commencing the Installation. Failure to follow these instructions may result in a fire hazard and void the warranty

For Specification See: www.warmington.co.nz

Copyright ©

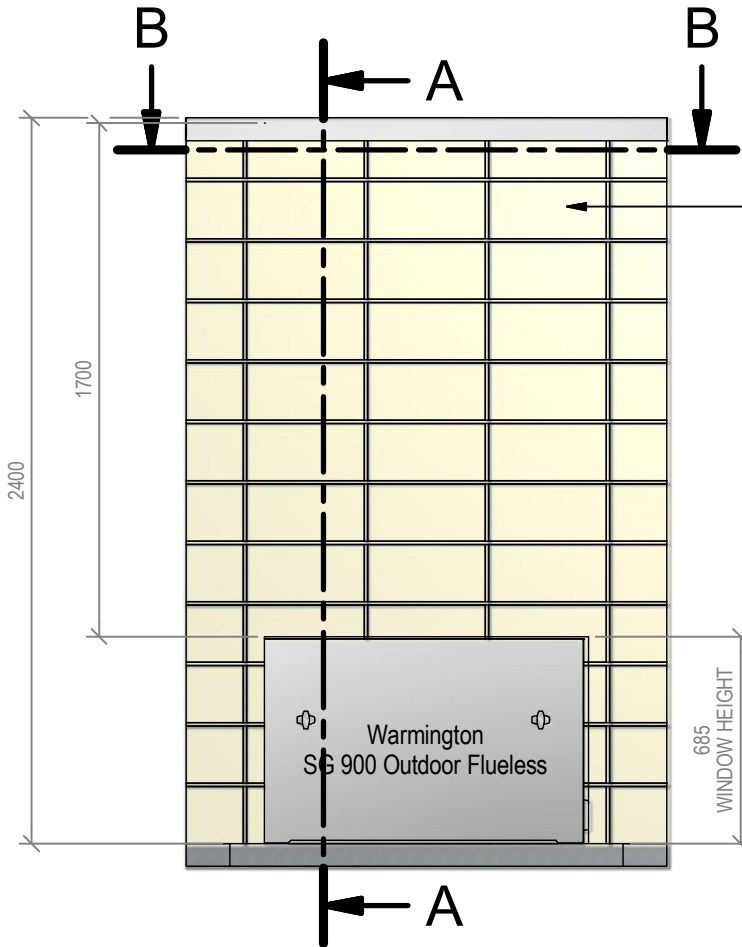

NO COMBUSTABLE MATERIAL TO BE USED IN OR ON THIS AREA

NOTE:
GAS TEMPERATURE WILL EXCEED 150°C RUNNING UP THE FRONT FACE

REBATE TO REDUCE WATER ENTERING THE FIRE

THESE FIRES ARE FOR OUTSIDE USE ONLY NOT TO BE INSTALLED INDOORS

ENSURE VENTING IS NOT RESTRICTED OR THE AIR FLOW IMPINGES ON ANY COMBUSTIBLE MATERIAL

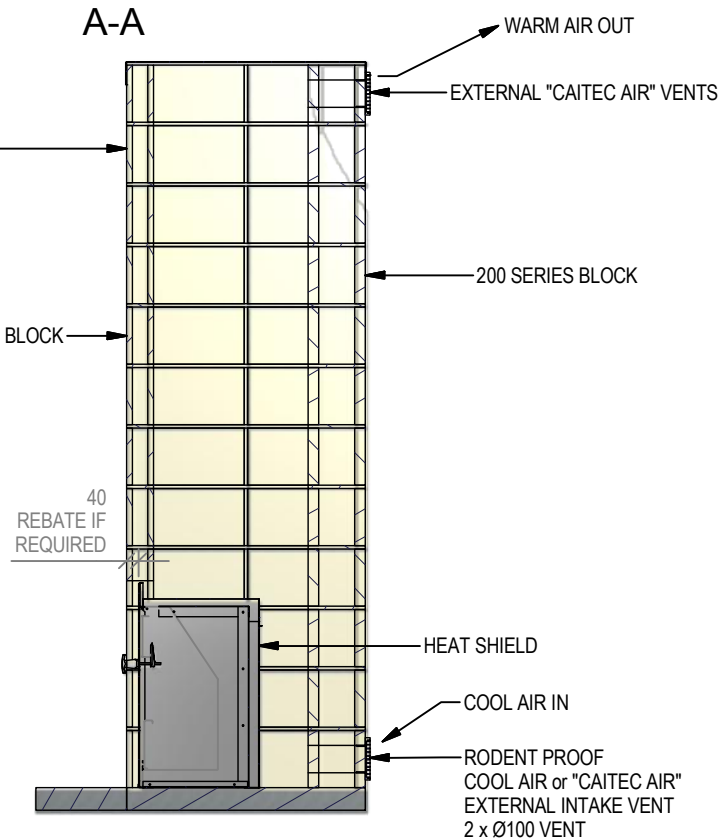

Warmington Industries Ltd.			
PH: 09 273 9227 FAX: 09 273 9241 WEB: www.warmington.co.nz			
TITLE	SG 900 OUTDOOR FLUELESS HEBEL ENCLOSURE	DATE	13/04/11
DRAWN	ROBERT	REVISION	01
SCALE	NOT TO SCALE		